



a **NUCOR** company

ENERGY CODE SOLUTIONS

Energy codes can be complicated.
We'll help you find the answer.

Energy Code Decoders

Energy regulations are becoming increasingly complex and what it takes to meet them is constantly changing.



Meet the major players that influence your energy decisions.

As the building contractor, it's your job to make sure you know, understand and meet all the compliance requirements and specifications at a price point that wins bids. That's why we've assembled a dedicated team of energy experts equipped with the knowledge and tools to help you meet the necessary energy codes in the most cost-effective manner possible. We are your Energy Code Decoders, and we're here to help. Our experienced and knowledgeable team can provide guidance for your energy needs. From state codes to regional climate requirements and everything in between, we've got you covered.

When it comes to energy, there are a variety of different regulating organizations, codes and requirements. This brochure will expand on those elements and help you better navigate the complex world of energy-compliant construction.



Keeping Things up to Code

International Energy Conservation Code (IECC)

The International Energy Conservation Code is a model code that regulates minimum energy conservation requirements for new buildings. The IECC references ASHRAE 90.1 in addressing energy conservation requirements for all aspects of energy uses in both commercial and residential construction – including heating and ventilating, lighting, water heating, and power usage for applications and building systems.

American Society of Heating, Refrigeration and Air-Conditioning Engineers (ASHRAE)

ASHRAE 90.1 provides the minimum requirements for energy-efficient design of most buildings except low-rise residential buildings. It offers in detail the minimum energy-efficient requirements for the design and construction of new buildings and their systems, new portions of buildings and their systems, and new systems and equipment in existing buildings, as well as criteria for determining compliance with these requirements. It is an indispensable reference for engineers and other professionals involved in the design of buildings and building systems. While some ASHRAE 90.1 standards can be stringent and continuously changing, our experienced staff and specially designed products can help you stay up to code.

These codes are updated routinely and released on differing schedules. They only come into force when states, provinces, or municipalities elect to write, enact and enforce laws and regulations relating to that code.

R-Value vs U-Factor

Knowing what R-value and U-factor mean is key to decoding energy issues and to selecting products that best suit the climate zone you are building in. R-value is essentially a product's resistance to heat flow, which means that the higher the product's R-value, the better it is at insulating a building and improving energy efficiency. Conversely, U-factor measures the rate of heat transfer. This means that products with a lower U-factor will be more energy efficient.

$$R=1/U \text{ \& } U=1/R$$

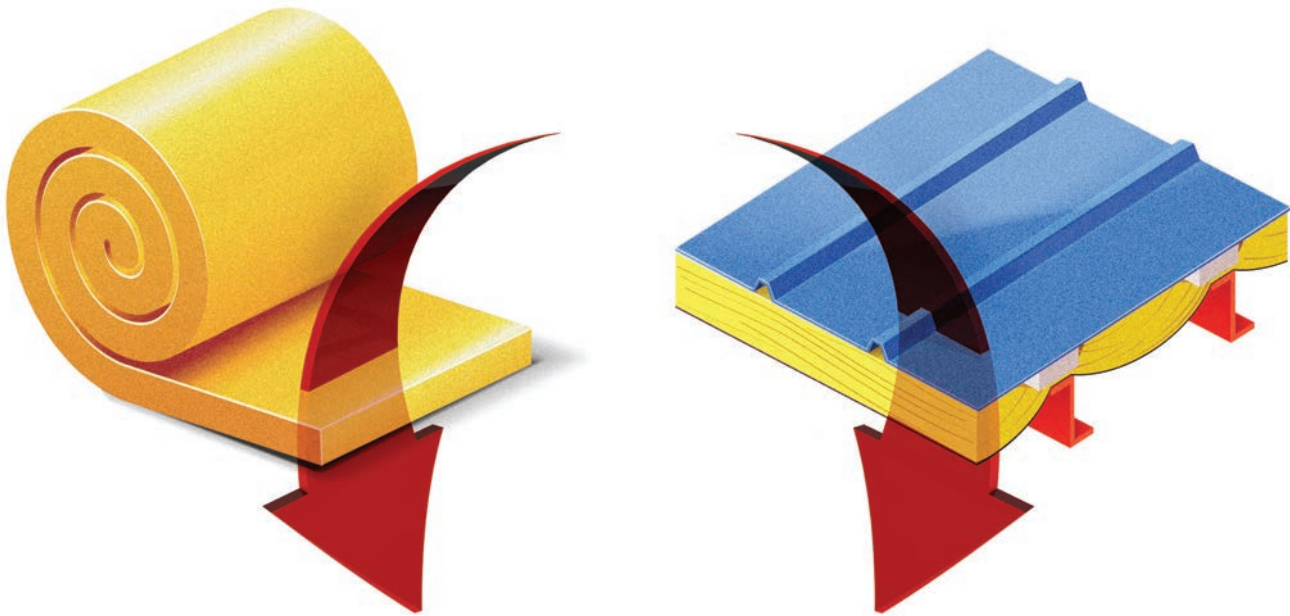

What is R-Value?

R-value tells us how well a particular construction material insulates. The higher the R-value, the better the insulation and the more energy you will save. An R-value only applies to specific materials, not to systems.

What is U-Factor?

U-factor is generally used to rate systems like an insulated wall or roof assembly. The lower the U-factor, the more energy efficient the assembly in question will be. A U-factor is typically a low number because it is a rating of how much heat energy is lost or gained.

Climate Zones

State, Provincial, and Local Codes

Many states and provinces have their own energy codes, which are often modeled after the IECC, NECB, or ASHRAE 90.1 standards. These model codes can be adopted as written in their entirety or regions can select only portions of the code to implement. Some jurisdictions have also chosen to modify the code language to relax it while others have elected to make it more stringent. A few areas choose to have no guiding energy codes or regulations at all while some others still require older versions. But more and more localities are choosing to update their regulations and adhere to newer, more rigorous codes. The more recent the year of the standard they model their codes after, the stricter, more energy efficient the requirements are. It is important to check the local regulations and requirements before beginning a construction project.

Climate Zones

The state, provincial, and local codes include energy requirements for whatever climate zone they are in. There are multiple climate zones, each with its own energy requirements. Since most states and provinces have more than one climate zone within their borders, it is crucial that you know the climate zone requirements for the location you are building.



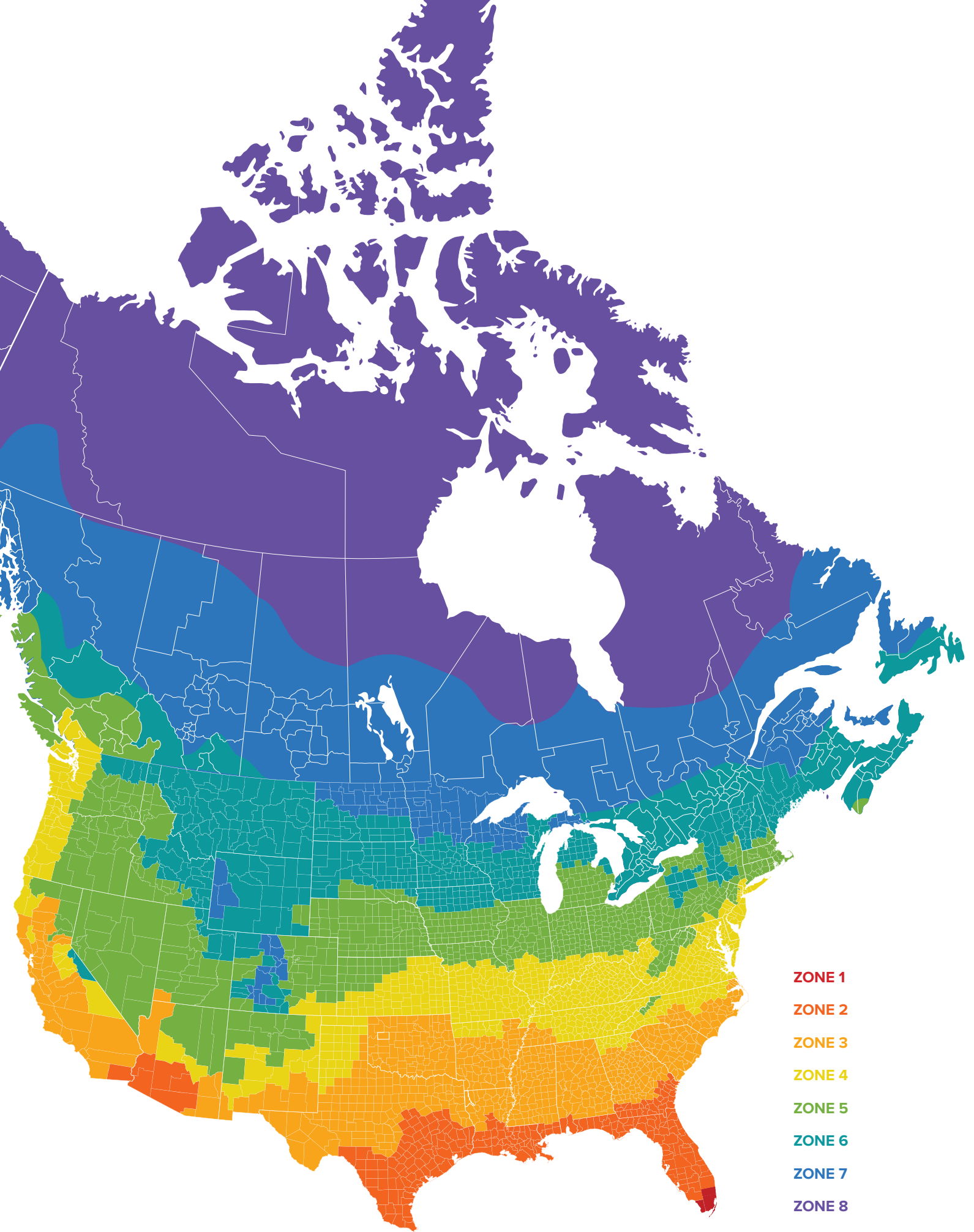

- ZONE 1**
- ZONE 2**
- ZONE 3**
- ZONE 4**
- ZONE 5**
- ZONE 6**
- ZONE 7**
- ZONE 8**

Insulation Terminology

We highlight key terms and definitions listed in the aforementioned energy codes for roof and wall insulation assemblies in regard to metal buildings.

The energy standards such as IECC, NECB, and ASHRAE can often times be challenging to grasp, with wording that can get difficult and confusing. So we've compiled a list of some of the key terms you need to know when trying to make your building code compliant.

Single Layer

A single layer of faced fiberglass insulation draped perpendicular over the purlins or girts. A thermal spacer block may be required at the purlin or girt locations.

Double Layer

A solution with two layers of fiberglass insulation. Double layer systems contain two R-values. In roof systems, the first is for faced fiberglass insulation installed perpendicular to the purlins and compressed between the purlin and panel. The second R-value is unfaced fiberglass insulation installed above the first layer and parallel to the purlins. In wall systems, the first R-value is installed in the cavity between the girts, not compressed by the framing. The second R-value is for insulation compressed between girts and the panel. A thermal spacer block may be required at the purlin or girt locations.

Liner System

A liner system is similar to the filled cavity system, however the liner system can be used with through-fastened roofs in addition to standing seam. The liner system has a continuous membrane that is installed below the purlins and uninterrupted by framing members.

Filled Cavity

A standing seam roof with filled cavity fiberglass insulation. This assembly also has two R-values. The first R-value comes from the faced or unfaced insulation that is installed between the purlins. The second R-value is for the unfaced insulation installed above the first layer, perpendicular to the purlins and compressed when the metal roof panels are attached. A supporting structure retains the bottom of the first layer at the prescribed depth required for the full thickness of insulation. A thermal spacer block is typically required at the purlin locations.

Continuous Insulation

Assembly method where insulation is installed inside or outside the purlins or girts and is uncompressed and uninterrupted by framing members.

R-Boost Elevated Insulation System

Nucor Buildings Group's proprietary solution designed to increase your roof's thermal performance through an elevated roof insulation system. This economical solution provides a platform for a secondary layer of blanket insulation –significantly expanding your insulation capacity.

See a detailed graphic on page 21.



Methods to Compliance

Energy codes include mandatory requirements, along with various compliance methods that you can choose from based on your specific needs.

The mandatory requirements must be met in every building design no matter which compliance option is chosen. The three main compliance options are the Prescriptive Method, Building Envelope Trade-Off Method and Energy Cost Budget Method.

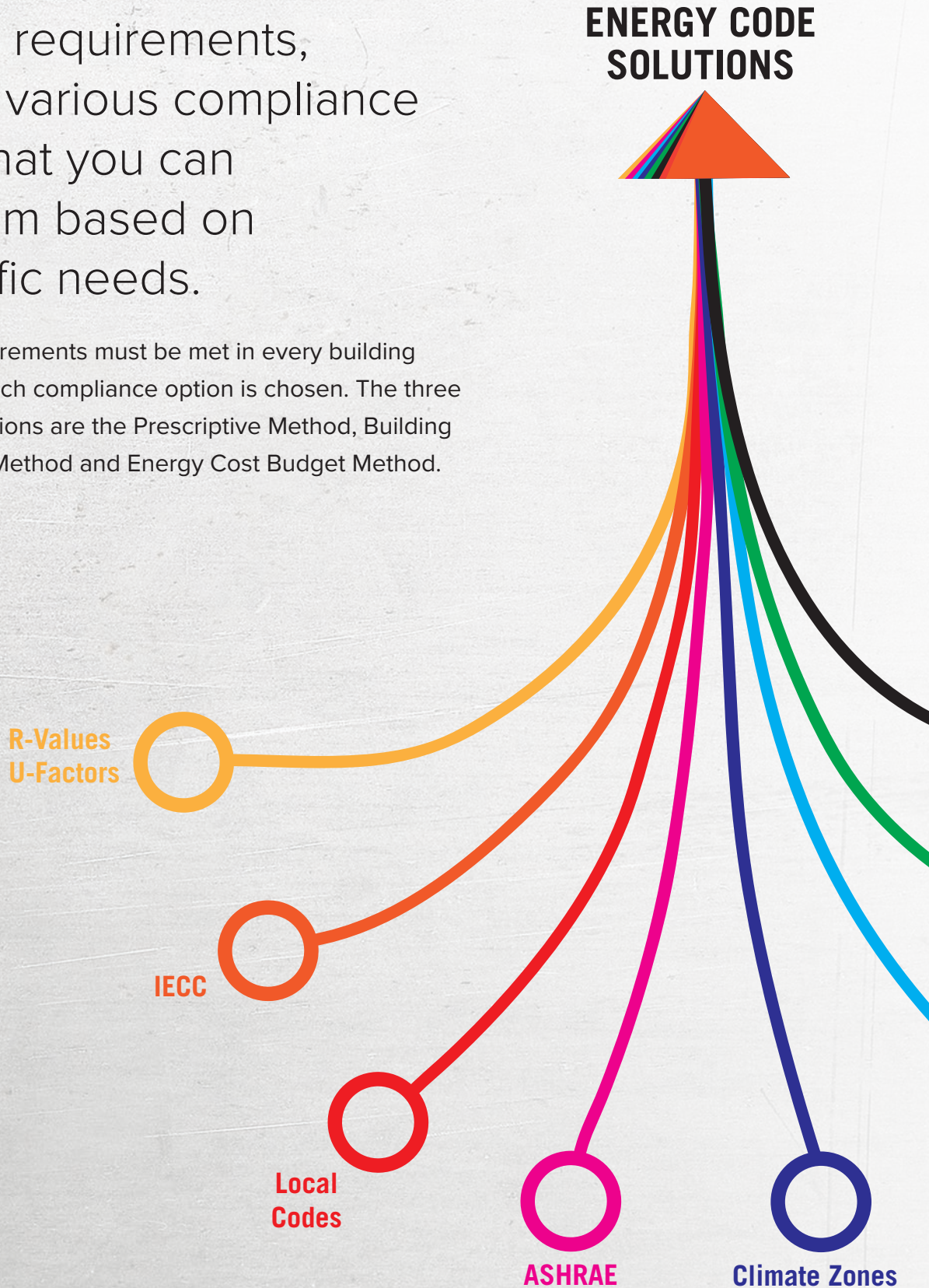

Prescriptive Method

The Prescriptive option is the easiest method to comply with, but it's not always the most cost effective. With this option, there is no need to know what mechanical systems or lighting is going to be used. The Prescriptive Method doesn't allow for trade-offs, and the requirements may have to be exceeded in some cases due to whatever products or assemblies are available to you.

Building Envelope Trade-Off Method

The Building Envelope Trade-Off option provides much greater flexibility than the Prescriptive Method. It allows the use of certain components that, by themselves, may not meet the Prescriptive requirements. But, this method allows for trade-offs in the form of roof with walls, walls with roof, windows, doors, slab insulation, etc. in order to meet your specific requirements.

Energy Cost Budget Method

The Energy Cost Budget option is the only method that provides the theoretical expected energy consumption of a proposed building versus a building that satisfies the minimum requirements. It's also the only method that allows for trade-offs between mechanical and lighting systems and the building envelope. This is the most complex method and will almost always require an energy consultant to be retained to compare and contrast all of the various scenarios. Spray foam can also be used as a means of insulation with this option.

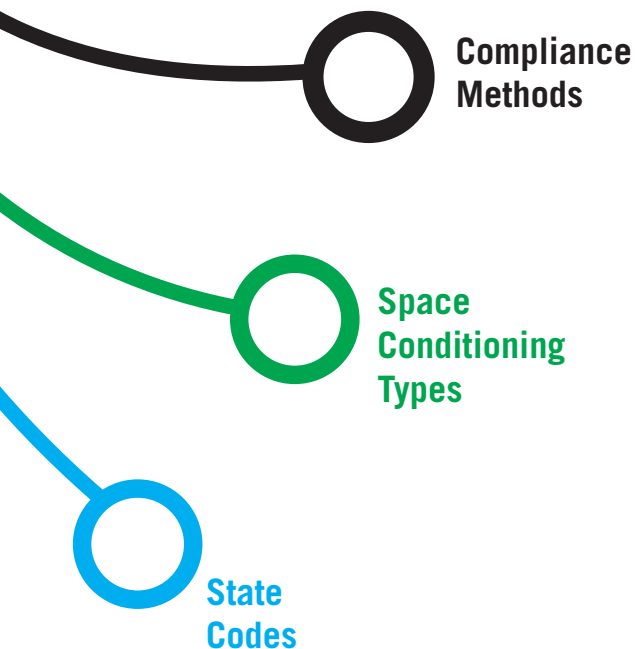

Space Conditioning Types

According to ASHRAE, any area enclosed within a building is considered a space.

Commercial space conditioning accounts for about 7.0 quads of primary energy per year, or about 40% of total commercial energy use in the United States. There are three basic types of space conditioning defined by building standards, and each one requires different levels of thermal performance.

Conditioned Space

IECC and NECB define conditioned space similarly as an area, room, or space within the building thermal envelope, the temperature of which is directly or indirectly heated or cooled to limit variation in response to the exterior ambient temperature. Spaces are indirectly heated or cooled where they communicate through openings with conditioned spaces; where they are separated from conditioned spaces by uninsulated walls, floors or ceilings; or where they contain uninsulated ducts, piping or other sources of heating or cooling.



ASHRAE 90.1 defines a conditioned space as a cooled space, heated space or indirectly conditioned space. Cooled, heated and indirectly conditioned spaces are defined as follows:

Cooled Space:

An enclosed space within a building that is cooled by a cooling system whose sensible output capacity exceeds 5 Btu/h-ft² of floor area in 2007, 2010, and 2013, and exceeds 3.4 Btu/h-ft² of floor area in 2016, 2019, and 2022.

Heated Space:

An enclosed space within a building that is heated by a heating system whose output capacity relative to the floor area is greater than or equal to the minimum heating output specified for its climate zone.

Indirectly Conditioned Space:

An enclosed space within a building that is not a heated space or a cooled space, which is heated or cooled indirectly by being connected to adjacent conditioned and/or semiheated spaces.

Semiheated Space

A semiheated space only applies to ASHRAE 90.1, not IECC or NECB. ASHRAE 90.1 states that a semiheated space is an enclosed space within a building that is heated by a heating system whose output capacity is greater than or equal to 3.4 Btu/h-ft² of floor area but is not a conditioned space.

Unconditioned Space

An unconditioned space is an enclosed space within a building that is not a conditioned space or a semiheated space. Crawlspace, attics and parking garages with natural or mechanical ventilation are not considered enclosed spaces.



Our Solutions

At Kirby Building Systems, we have a multitude of energy solutions to help you adhere to even the strictest codes. From apps and software to innovative products and expertise – when it comes to meeting code, you can count on us.



Cool Coatings

Lower your energy costs and make your buildings stand out with our vibrant line of cool coatings. All of our wall and roof panels are available with our SP or PVDF cool coating finishes. Vivid color. Eco-efficiency. Low-maintenance reliability. To be considered cool, products must have a solar reflectance of at least 25%. Another important factor is thermal emittance. Put these two factors together and you get the solar reflectance index – which is the measure of a panel’s ability to reflect solar heat.

Daylighting

Daylighting with Prismatic Skylights is the controlled admission of natural sunlight into your building using diffused skylights in conjunction with energy-efficient lighting and a daylight-responsive lighting control system – helping you get up to code and maximizing your energy savings. Daylighting significantly reduces the need for electric light, which significantly cuts down on energy costs. Our modern prismatic skylights transmit more light than conventional skylights while diffusing 100% of incoming rays. For many institutional and commercial buildings, strategic daylighting can reduce total energy costs by as much as one-third.



Condensation

Condensation can be caused by non-vented air spaces remaining between insulation and metal panel. Therefore, it is important to completely fill cavities and keep insulation tight against the metal panel.

In some cases, prescriptive code-specified insulation solutions do not provide enough thickness to fill cavity from inside of purlin or girt to panel. We recommend that purlin and girt depth be accounted for when determining insulation thickness.



Condensation

Condensation occurs when warm, moist air comes in contact with cooler surfaces. Warm air can hold more moisture than cool air so when the air cools as it contacts the cooler surface, the moisture is released in the form of condensation. This can cause corrosion of metal components and degradation of the thermal performance of the insulation.

Within a metal building, condensation can appear as visible or concealed. When visible, it can be seen as water on windows, doors, framing members, etc. Signs of concealed condensation may be dripping or sagging insulation, wet spots or stains on walls or ceilings, and mold or mildew. We recommend filling the cavity above the suspension system completely to hold insulation against the roof panel in order to minimize condensation and roof rattle. This may require more insulation than energy codes prescribe.



Insulated Metal Panels

Our insulated wall and roof panels are the ultimate in energy efficiency.

Metl-Span IMPs provide outstanding long-term air, thermal, water, and vapor control in a simple, yet brilliantly engineered single panel suitable for any climate. In fact, Metl-Span IMPs are so effective and versatile, they are often utilized not just for exterior walls, but roofs where performance is even more critical. With robust insulating values up to a staggering R-70, Metl-Span IMPs easily meet energy codes for every North American climate zone.

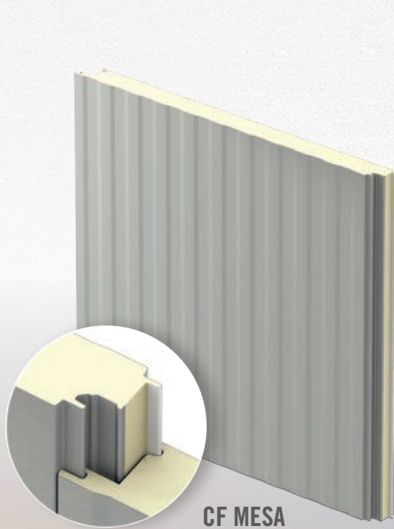

CF MESA

U-FACTOR (BTU/h-ft²·°F)

PANEL WIDTH: 42"

Thickness	U-Factor
35"	
2"	0.059
2.5"	0.046
3"	0.039
4"	0.029
5"	0.023
6"	0.019
8"	0.014

R-VALUE (h-ft²·°F/BTU)

PANEL WIDTH: 42"

Thickness	R-Value
35"	
2"	17.5
2.5"	21.9
3"	26.2
4"	35.0
5"	43.7
6"	52.5
8"	70.0

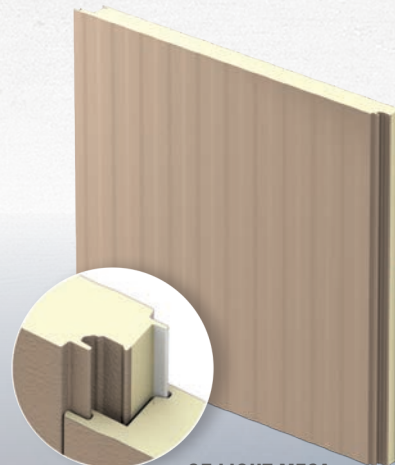

CF LIGHT MESA

U-FACTOR (BTU/h-ft²·°F)

PANEL WIDTH: 42"

Thickness	U-Factor
35"	
2"	0.059
2.5"	0.046
3"	0.039
4"	0.029
5"	0.023
6"	0.019
8"	0.014

R-VALUE (h-ft²·°F/BTU)

PANEL WIDTH: 42"

Thickness	R-Value
35"	
2"	17.5
2.5"	21.9
3"	26.2
4"	35.0
5"	43.7
6"	52.5
8"	70.0



Nucor Buildings Group
project utilizing Metl-Span
insulated metal panels

Insulated Metal Wall Panels

Due to their excellent insulating and weatherproofing characteristics, as well as their very competitive installation cost, Metl-Span panels are ideally suited for use as walls, ceilings and roofs for commercial, industrial and institutional buildings of virtually any scale, in both new and retrofit construction.

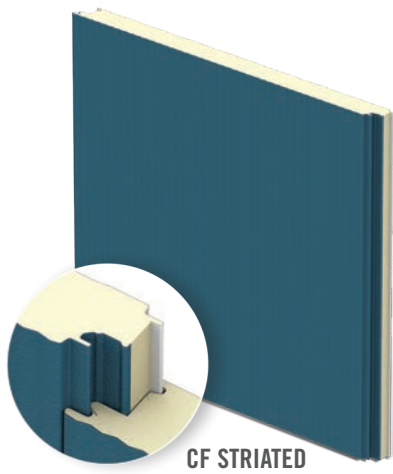

CF STRIATED

U-FACTOR (BTU/h-ft²·°F)

PANEL WIDTH: 42"

Thickness	U-Factor
35"	
2"	0.059
2.5"	0.046
3"	0.039
4"	0.029

R-VALUE (h-ft²·°F/BTU)

PANEL WIDTH: 42"

Thickness	R-Value
35"	
2"	17.5
2.5"	21.9
3"	26.2
4"	35.0

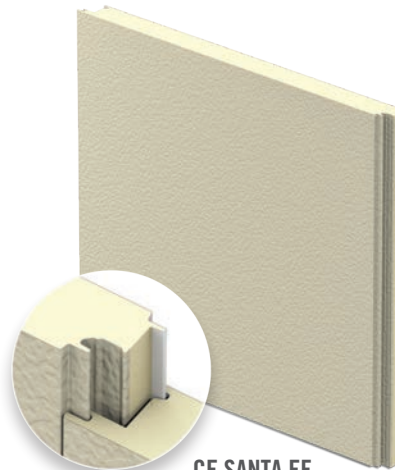

CF SANTA FE

U-FACTOR (BTU/h-ft²·°F)

PANEL WIDTH: 42"

Thickness	U-Factor
35"	
2"	0.059
2.5"	0.046
3"	0.038
4"	0.028

R-VALUE (h-ft²·°F/BTU)

PANEL WIDTH: 42"

Thickness	R-Value
35"	
2"	17.5
2.5"	21.9
3"	26.2
4"	35.0



CF FLUTE

U-FACTOR (BTU/h-ft²·°F)

PANEL WIDTH: 42"

Thickness	U-Factor
35"	
2"	0.060
2.5"	0.047
3"	0.039
4"	0.029
5"	0.023
6"	0.020
8"	0.015

R-VALUE (h-ft²·°F/BTU)

PANEL WIDTH: 42"

Thickness	R-Value
35"	
2"	17.5
2.5"	21.9
3"	26.2
4"	35.0
5"	43.7
6"	52.5
8"	70.0

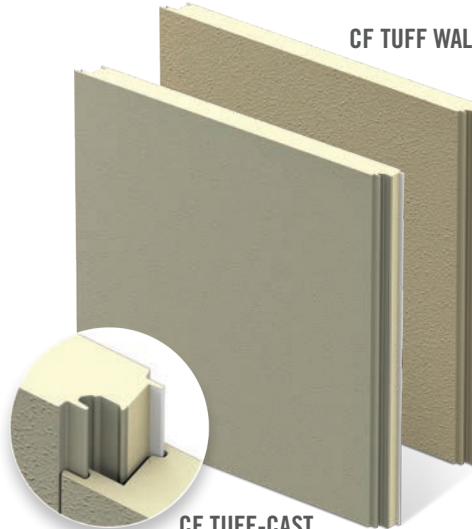

CF TUFF WALL

CF TUFF-CAST

U-FACTOR (BTU/h-ft²·°F)

PANEL WIDTH: 42"

Thickness	U-Factor
35"	
2"	0.059
2.5"	0.046
3"	0.038
4"	0.028
5"	0.023
6"	0.019

R-VALUE (h-ft²·°F/BTU)

PANEL WIDTH: 42"

Thickness	R-Value
35"	
2"	17.5
2.5"	21.9
3"	26.2
4"	35.0
5"	43.7
6"	52.5

Insulated Metal Roof Panels

Our CFR-IMP roof panel provides an unsurpassed weathertight seal and service life. Ideal for commercial, industrial and institutional markets, the panel can be used on roof slopes as low as 1/2": 12".

U-FACTOR (BTU/h-ft²·°F)

PANEL WIDTH: 42"

Thickness	U-Factor
35"	
2"	0.065
2.5"	0.052
3"	0.044
4"	0.033
5"	0.027
6"	0.022

R-VALUE (h-ft²·°F/BTU)

PANEL WIDTH: 42"

Thickness	R-Value
35"	
2"	17.5
2.5"	21.9
3"	26.2
4"	35.0
5"	43.7
6"	52.2

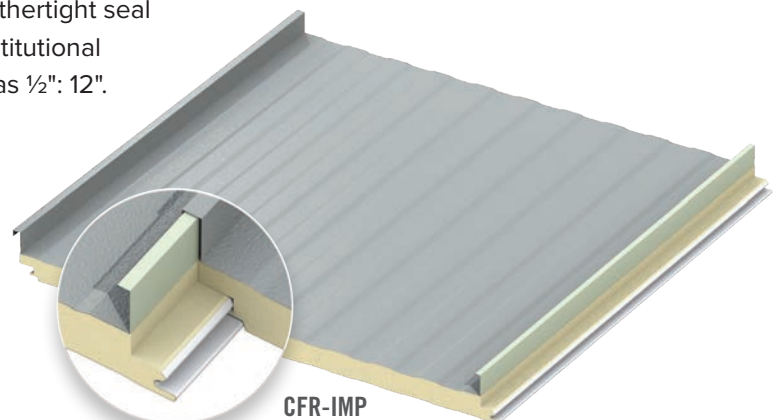

CFR-IMP

Insulated Roof Systems

Our insulated roof systems will help keep you energy compliant in any climate, season after season.

RSL.3

Single Layer Faced Blanket

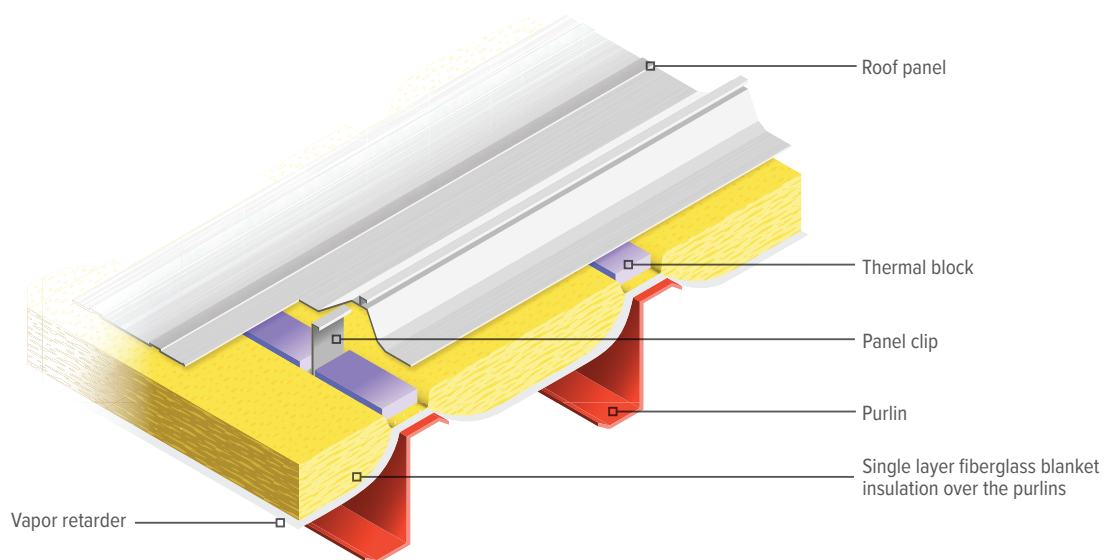

RDL.3

Sag-N-Bag (DOUBLE LAYER)

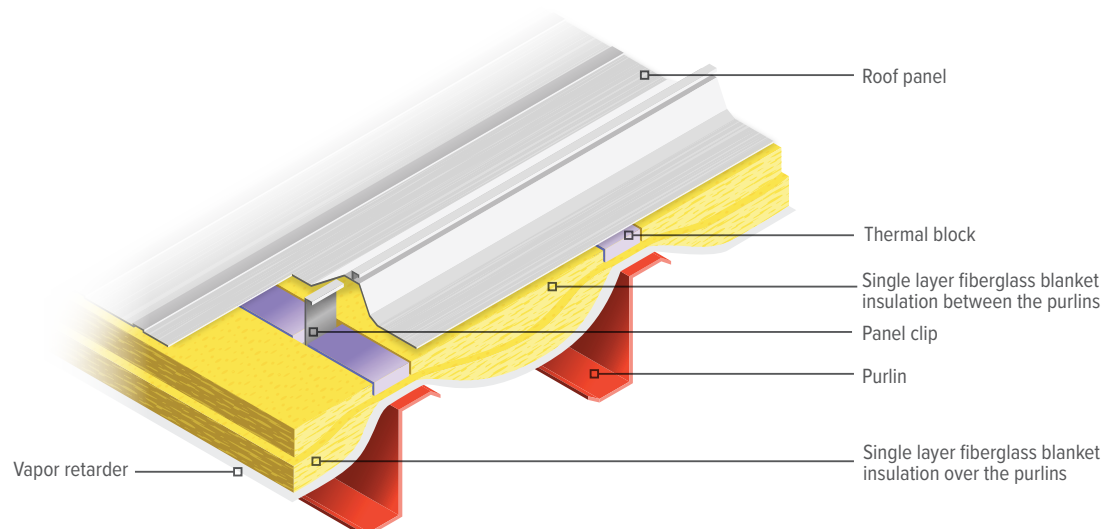

RES.3

Energy Saver (LINER SYSTEM)

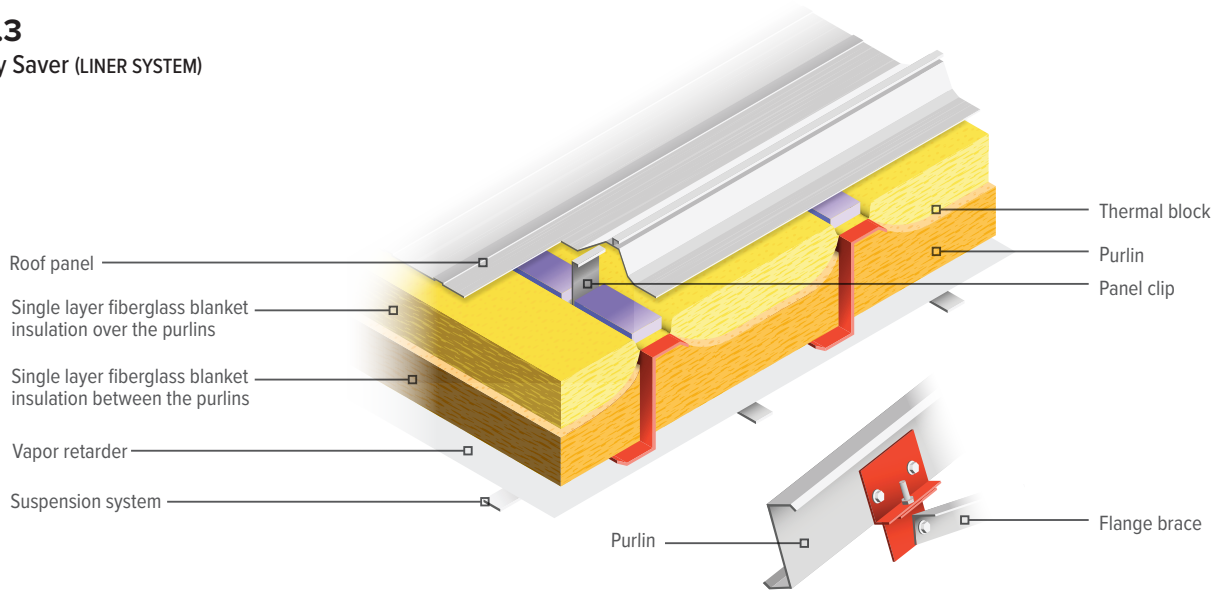

RFC.3

Long Tab & Banding (FILLED CAVITY)

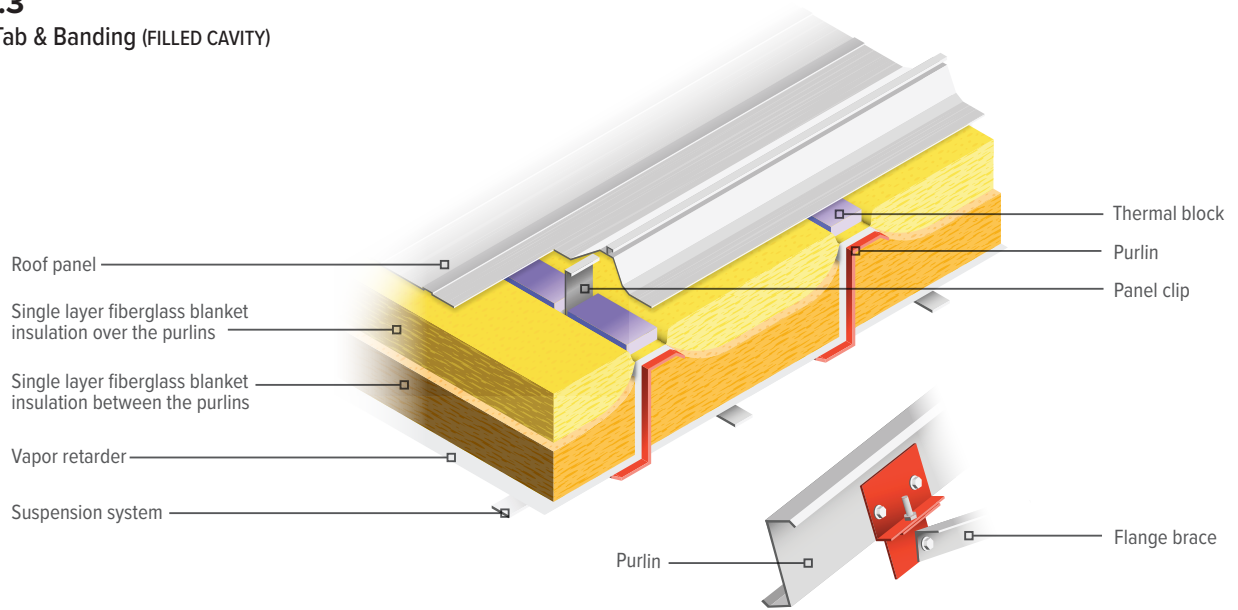

RIMP

Insulated Metal Panel

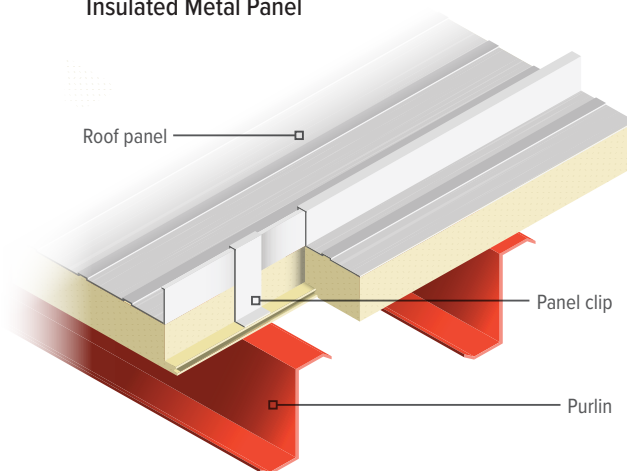

RRB.1

R-Boost Elevated Insulation

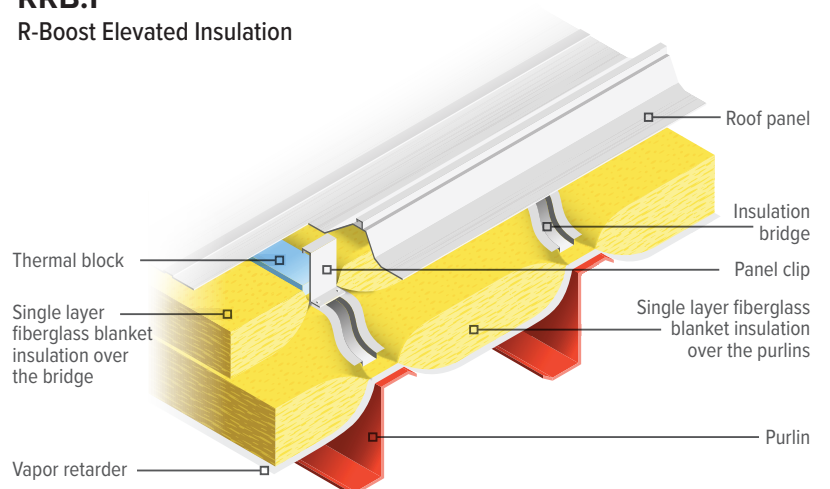

Insulated Wall Systems

Our insulated wall systems can keep you up to code in the heat or the cold.

WSL.1
Single Layer Faced Blanket

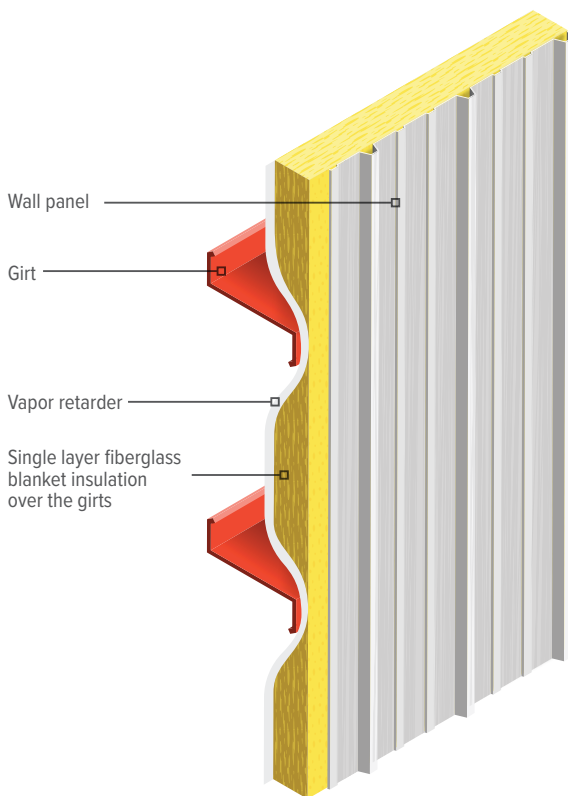

WES.2
Energy Saver Double Layer

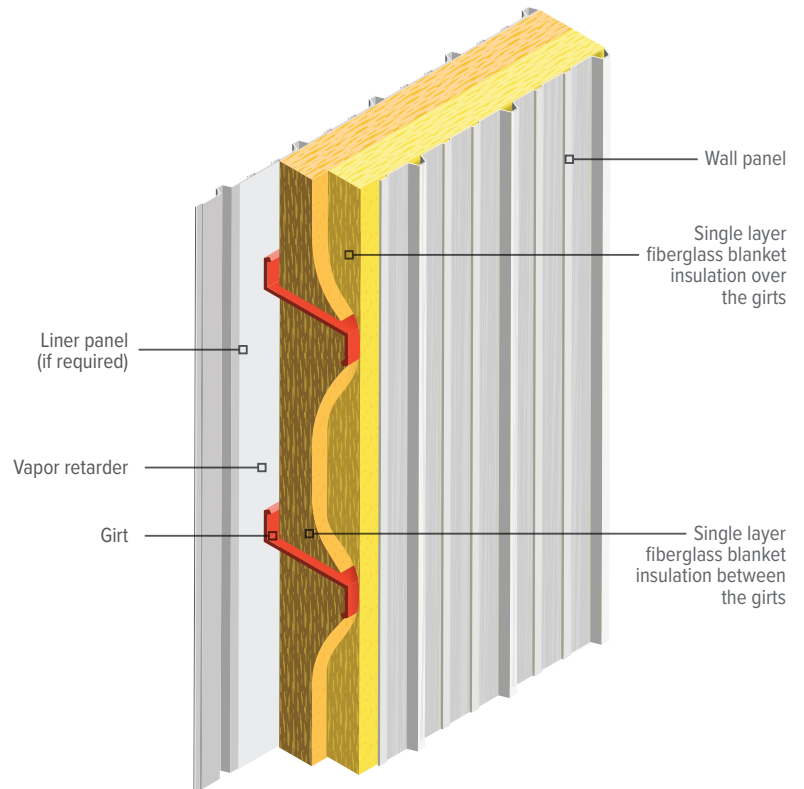

WDL.1

Double Layer Wall with Thermal Block

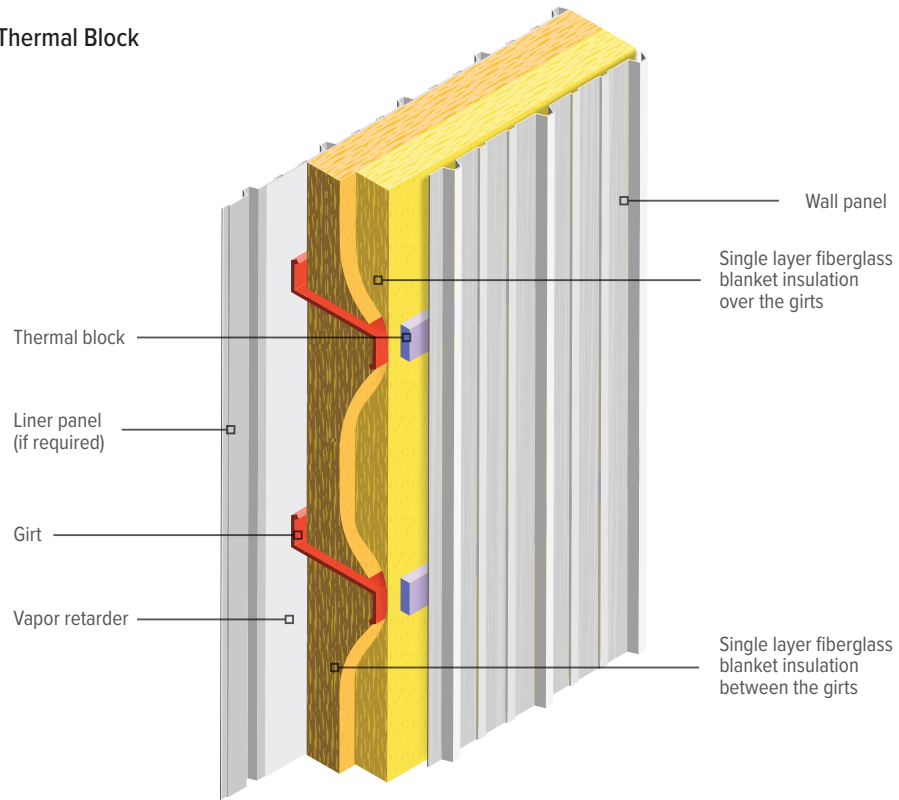

WES.1

Energy Saver Single Layer in Cavity

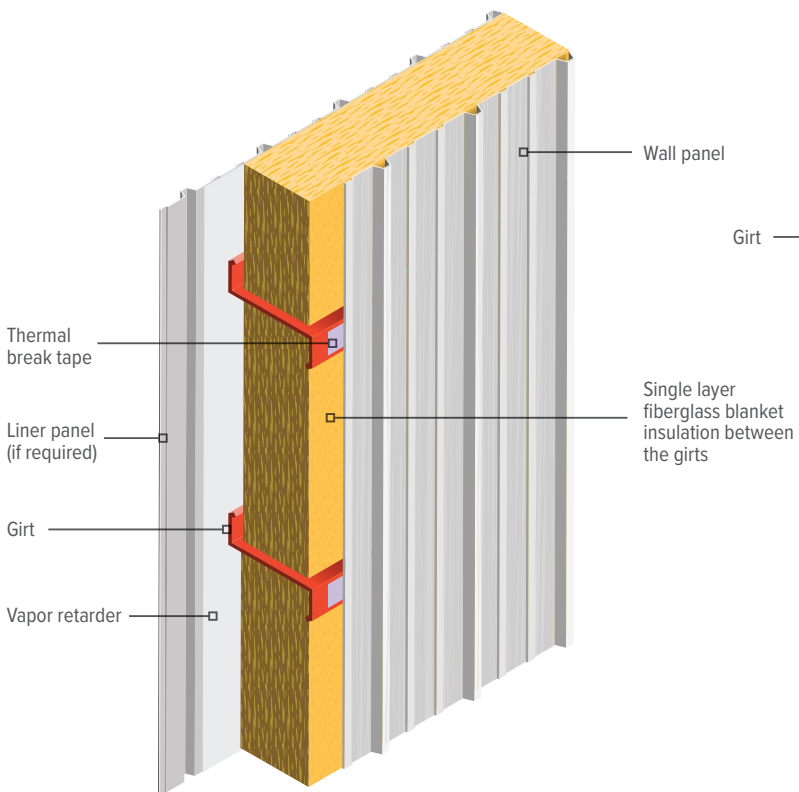

WIMP

Insulated Metal Panel

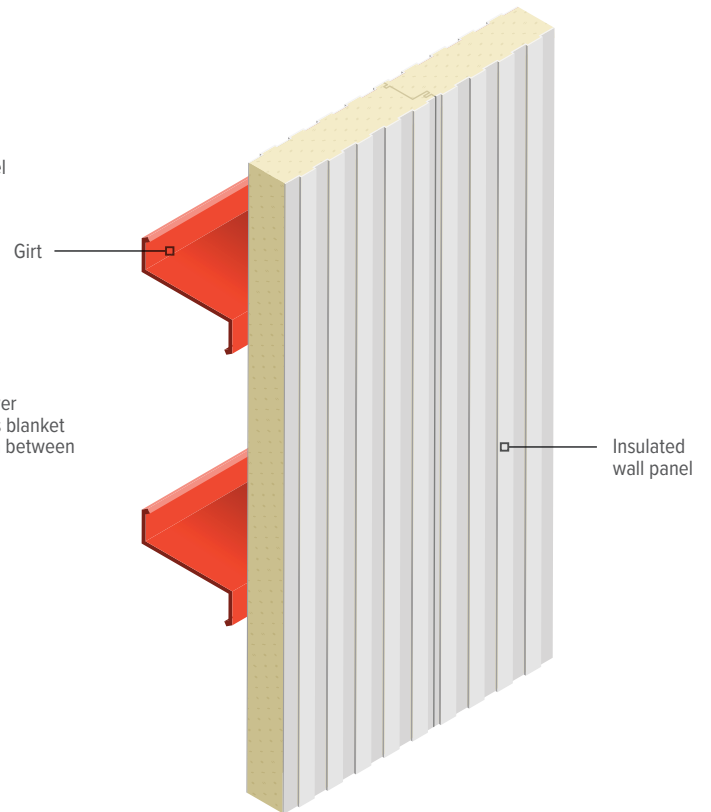

Energizing Solutions at Your Fingertips

Kirby Building Systems Toolbox and Dashboard

The Toolbox app and Builder Dashboard provide the latest energy code solutions available at your fingertips. Available only to Authorized Builders, these platforms provide an interactive energy code map with recent code update information, and are packed with many other useful tools.

Determine Your Compliance with COMcheck™

Just type in the necessary building information and COMcheck™ will determine whether or not you are compliant with your specific energy code, as well as help you decide what needs to be changed in order to become compliant. COMcheck™ lets you run your building using assemblies of different performances, giving you the ability to select the most cost-effective options to become code compliant.

Product Bulletins

Never miss an important product change or update with access to our product bulletin portal.

Nucor Steel Store

The Nucor Steel Store is the single largest source of custom steel construction products available for purchase online.

ShakeoutPro®

ShakeoutPro® is a unique mobile app that has been specifically developed to help Builders and erectors save time receiving, unloading and staging steel at the job site.

eQuote

eQuote is a proprietary, industry-leading pricing system designed to provide the most accurate, detailed scope documents to successfully and efficiently quote projects.

Builders Resources

The most convenient way to access the Builders Resources information you need—all in one place.

Message Center

Stay up to date when you're on the go with easy access to the latest news and announcements.

Envelope Energy Codes

Use our comprehensive energy code charts to ensure you're up to code, no matter the building, no matter the climate.

Envelope Energy Codes - U.S. Metal Building Conditioned Space - ASHRAE 90.1

ASHRAE 90.1 2007		Zone 1	Zone 2	Zone 3	Zone 4	Zone 5	Zone 6	Zone 7	Zone 8	
Prescriptive Compliance	Roof	U-Factors	0.065 / HA 0.082	0.065 / HA 0.078	0.065 / HA 0.076	0.065	0.065	0.065	0.065	0.049
		Fiberglass w/1" TSB (DETAIL)	R-19 (RSL.3) / HA R-13 (RSL.3)	R-19 (RSL.3) / HA R-13 (RSL.3)	R-19 (RSL.3)	R-19 (RSL.3)	R-19 (RSL.3)	R-19 (RSL.3)	R-19 (RSL.3)	R-13 + R-19 (RDL.3)
		IMPs (DETAIL)	2" (RIMP)	2" (RIMP)	2" (RIMP)	2" (RIMP)	2" (RIMP)	2" (RIMP)	2" (RIMP)	3" (RIMP)
	Walls	U-Factors	0.113	0.113	0.113	0.113	0.113	0.113	0.057	0.057
		Fiberglass (DETAIL)	R-13 (WSL.3)	R-13 (WSL.3)	R-13 (WSL.3)	R-13 (WSL.3)	R-13 (WSL.3)	R-13 (WSL.3)	R-19 (WES.1) or R-13 + R-13 (WES.2)	R-19 (WES.1) or R-13 + R-13 (WES.2)
		IMPs (DETAIL)	2" (WIMP)	2" (WIMP)	2" (WIMP)	2" (WIMP)	2" (WIMP)	2" (WIMP)	2.5" (WIMP)	2.5" (WIMP)

ASHRAE 90.1 2010		Zone 1	Zone 2	Zone 3	Zone 4	Zone 5	Zone 6	Zone 7	Zone 8	
Prescriptive Compliance	Roof	U-Factors	0.065 ¹	0.055	0.055	0.055	0.055	0.049	0.049	0.035
		Fiberglass w/R-3.5 TSB UNO (DETAIL) Purlins spaced nominally 5' o/c	R-19 (RSL.3)	R-25 ² TRAP (RSL.3) or R-13 + R-13 (RDL.3)	R-25 ² TRAP (RSL.3) or R-13 + R-13 (RDL.3)	R-25 ² TRAP (RSL.3) or R-13 + R-13 (RDL.3)	R-25 ² TRAP (RSL.3) or R-13 + R-13 (RDL.3)	R-30 ² TRAP (RSL.3) or R-13 + R-19 (RDL.3)	R-30 ² TRAP (RSL.3) or R-13 + R-19 (RDL.3)	R-19 + R-11 LS (RES.3) or R-19 + R-19 + R-3.75 TSB (RRB.1)
		IMPs (DETAIL)	2" (RIMP)	2.5" (RIMP)	2.5" (RIMP)	2.5" (RIMP)	2.5" (RIMP)	3" (RIMP)	3" (RIMP)	4" (RIMP)
	Walls	U-Factors	0.093	0.093	0.084	0.084	0.069	0.069	0.057	0.057
		Fiberglass (DETAIL)	R-19 (WES.1)	R-19 (WES.1)	R-19 (WES.1)	R-19 (WES.1)	R-25 + R-0.75 TSB (WES.1)	R-25 + R-0.75 TSB (WES.1)	R-30 + R-0.75 TSB (WES.1)	R-30 + R-0.75 TSB (WES.1)
		IMPs (DETAIL)	2" (WIMP)	2" (WIMP)	2" (WIMP)	2" (WIMP)	2" (WIMP)	2" (WIMP)	2.5" (WIMP)	2.5" (WIMP)

ASHRAE 90.1 2013-2022		Zone 0 ³	Zone 1	Zone 2	Zone 3	Zone 4	Zone 5	Zone 6	Zone 7	Zone 8	
Prescriptive Compliance	Roof	U-Factors	0.041 ¹	0.041 ¹	0.041	0.041	0.037	0.037	0.031	0.029	0.026
		Loc Seam or CFR Panel Fiberglass w/R-3 TSB UNO (DETAIL) Avg. Purlin spacing min 52"	R-10 + R-19 + R-5 TSB FC (RFC.3) or R-19 + R-11 LS (RES.3)	R-10 + R-19 + R-5 TSB FC (RFC.3) or R-19 + R-11 LS (RES.3)	R-10 + R-19 + R-5 TSB FC (RFC.3) or R-19 + R-11 LS (RES.3)	R-10 + R-19 + R-5 TSB FC (RFC.3) or R-19 + R-11 LS (RES.3)	R-19 + R-11 LS (RES.3) or R-25 + R-8 LS (RES.3)	R-19 + R-11 LS (RES.3) or R-25 + R-8 LS (RES.3)	R-25 + R-11 LS (RES.3) or R-19 + R-25 + R-3.75 TSB (RRB.1) ⁴	R-30 + R-11 LS (RES.3) or R-19 + R-30 + R-5 TSB (RRB.1) ⁴	R-25 + R-11 + R-11 LS (RFC.3) or R-25 + R-38 + R-3.75 TSB (RRB.1) ⁴
		SS360 Panel Fiberglass w/R-3 TSB UNO (DETAIL) Avg. Purlin spacing min 52"	R-10 + R-19 + R-5 TSB FC (RFC.3) or R-19 + R-11 LS (RES.3)	R-10 + R-19 + R-5 TSB FC (RFC.3) or R-19 + R-11 LS (RES.3)	R-10 + R-19 + R-5 TSB FC (RFC.3) or R-19 + R-11 LS (RES.3)	R-10 + R-19 + R-5 TSB FC (RFC.3) or R-19 + R-11 LS (RES.3)	R-19 + R-11 LS (RES.3) or R-25 + R-8 LS (RES.3)	R-19 + R-11 LS (RES.3) or R-25 + R-8 LS (RES.3)	R-25 + R-11 LS (RES.3) or R-19 + R-30 + R-5 TSB (RRB.1)	R-30 + R-11 LS (RES.3) or R-19 + R-38 + R-3.75 TSB (RRB.1)	R-25 + R-11 + R-11 LS (RFC.3)
	IMPs (DETAIL)	4" (RIMP)	4" (RIMP)	4" (RIMP)	4" (RIMP)	4" (RIMP)	4" (RIMP)	5" (RIMP)	5" (RIMP)	6" (RIMP)	
	Walls	U-Factors	0.094	0.094	0.094	0.094	0.060	0.050	0.050	0.044	0.039
		Fiberglass (DETAIL) Avg. girt spacing min 52"	R-19 ² RR/A (WSL.3) or R-25 + R-0.75 TSB (WES.1)	R-19 ² RR/A (WSL.3) or R-25 + R-0.75 TSB (WES.1)	R-19 ² RR/A (WSL.3) or R-25 + R-0.75 TSB (WES.1)	R-19 ² RR/A (WSL.3) or R-25 + R-0.75 TSB (WES.1)	R-25 + R-0.375 TSB (WES.1)	R-25 + R-10 (WES.2)	R-25 + R-10 (WES.2)	R-25 + R-19 (WES.2)	R-30 + R-19 (WES.2) or R-25 + R-10 + R-3 TSB (WDL.1)
IMPs (DETAIL)		2" (WIMP)	2" (WIMP)	2" (WIMP)	2" (WIMP)	2" (WIMP)	2.5" (WIMP)	2.5" (WIMP)	3" (WIMP)	3" (WIMP)	

See pages 20 - 23 for roof and wall details illustrating the insulation solutions

Trap – NBG trapezoidal panel with R-3.75 TSB is required to achieve the performance indicated

HA – High Albedo Roof (has either solar reflectance of 0.70 and minimum thermal emittance of 0.75; or solar reflective index of 82)

RR/A – Reverse R-Panels or A-Panels are required to achieve the performance indicated

See page 30 for additional chart notes

Metal Building Semiheated Space - ASHRAE 90.1

ASHRAE 90.1 2007		Zone 1	Zone 2	Zone 3	Zone 4	Zone 5	Zone 6	Zone 7	Zone 8		
Prescriptive Compliance	Roof	U-Factors	1.280	0.167	0.097	0.097	0.097	0.097	0.097	0.072	
		Fiberglass w/1" TSB (DETAIL)	NR	R-6 (RSL.3)	R-10 (RSL.3)	R-10 (RSL.3)	R-10 (RSL.3)	R-10 (RSL.3)	R-10 (RSL.3)	R-10 (RSL.3)	R-19 (RSL.3)
		IMPs (DETAIL)	NR	2" (RIMP)	2" (RIMP)	2" (RIMP)	2" (RIMP)	2" (RIMP)	2" (RIMP)	2" (RIMP)	2" (RIMP)
	Walls	U-Factors	1.180	0.184	0.184	0.134	0.123	0.113	0.113	0.113	
		Fiberglass (DETAIL)	NR	R-6 (WSL.3)	R-6 (WSL.3)	R-10 (WSL.3)	R-11 (WSL.3)	R-13 (WSL.3)	R-13 (WSL.3)	R-13 (WSL.3)	
		IMPs (DETAIL)	NR	2" (WIMP)	2" (WIMP)	2" (WIMP)	2" (WIMP)	2" (WIMP)	2" (WIMP)	2" (WIMP)	

ASHRAE 90.1 2010		Zone 1	Zone 2	Zone 3	Zone 4	Zone 5	Zone 6	Zone 7	Zone 8	
Prescriptive Compliance	Roof	U-Factors	0.167	0.097	0.097	0.097	0.083	0.072	0.072	0.065
		Fiberglass w/R-3.5 TSB (DETAIL)	R-6 (RSL.3)	R-10 (RSL.3)	R-10 (RSL.3)	R-10 (RSL.3)	R-13 (RSL.3)	R-19 (RSL.3)	R-19 (RSL.3)	R-19 (RSL.3)
		IMPs (DETAIL)	2" (RIMP)	2" (RIMP)	2" (RIMP)	2" (RIMP)	2" (RIMP)	2" (RIMP)	2" (RIMP)	2" (RIMP)
	Walls	U-Factors	0.113	0.113	0.113	0.113	0.113	0.113	0.113	0.113
		Fiberglass (DETAIL)	R-13 (WSL.3)	R-13 (WSL.3)	R-13 (WSL.3)	R-13 (WSL.3)	R-13 (WSL.3)	R-13 (WSL.3)	R-13 (WSL.3)	R-13 (WSL.3)
		IMPs (DETAIL)	2" (WIMP)	2" (WIMP)	2" (WIMP)	2" (WIMP)	2" (WIMP)	2" (WIMP)	2" (WIMP)	2" (WIMP)

Metal Building Semiheated Space - ASHRAE 90.1 (CONT.)

ASHRAE 90.1 2013-2022		Zone 0 ³	Zone 1	Zone 2	Zone 3	Zone 4	Zone 5	Zone 6	Zone 7	Zone 8	
Prescriptive Compliance	Roof	U-Factors	0.115	0.115	0.096	0.096	0.082	0.082	0.060	0.037	0.037
		Fiberglass w/R-3 TSB (DETAIL)	R-10 (RSL.3)	R-10 (RSL.3)	R-19 (RSL.3)	R-19 (RSL.3)	R-19 (RSL.3)	R-19 (RSL.3)	R-19 + R-19 (RDL.3)	R-19 + R-11 LS (RES.3) or R-25 + R-8 LS (RES.3)	R-19 + R-11 LS (RES.3) or R-25 + R-8 LS (RES.3)
		IMPs (DETAIL)	2" (RIMP)	2" (RIMP)	2" (RIMP)	2" (RIMP)	2" (RIMP)	2" (RIMP)	2.5" (RIMP)	4" (RIMP)	4" (RIMP)
	Walls	U-Factors	0.352	0.352	0.162	0.162	0.162	0.094	0.094	0.072	0.060
		Fiberglass (DETAIL)	NR	NR	R-13 (WSL.3)	R-13 (WSL.3)	R-13 (WSL.3)	R-19 ² RR/A (WSL.3) or R-25 + R-0.75 TSB (WES.1)	R-19 ² RR/A (WSL.3) or R-25 + R-0.75 TSB (WES.1)	R-25 + R-0.75 TSB (WES.1)	R-25 + R-0.75 TSB (WES.1)
		IMPs (DETAIL)	NR	NR	2" (WIMP)	2" (WIMP)	2" (WIMP)	2" (WIMP)	2" (WIMP)	2" (WIMP)	2" (WIMP)

See pages 20 - 23 for roof and wall details illustrating the insulation solutions
 RR/A – Reverse R-Panels or A-Panels are required to achieve the performance indicated

Metal Building Conditioned Space - IECC

CONDITIONED SPACE IECC 2009		Zone 1	Zone 2	Zone 3	Zone 4 (EXCEPT MARINE)	Zone 5 Marine 4	Zone 6	Zone 7	Zone 8	
Prescriptive Compliance	Roof	U-Factors	0.065	0.055	0.055	0.055	0.055	0.049	0.049	0.035
		Fiberglass w/R-3.5 TSB UNO (DETAIL)	R-19 (RSL.3)	R-25 ² TRAP (RSL.3) or R-13 + R-13 (RDL.3)	R-25 ² TRAP (RSL.3) or R-13 + R-13 (RDL.3)	R-25 ² TRAP (RSL.3) or R-13 + R-13 (RDL.3)	R-25 ² TRAP (RSL.3) or R-13 + R-13 (RDL.3)	R-30 ² TRAP (RSL.3) or R-13 + R-19 (RDL.3)	R-30 ² TRAP (RSL.3) or R-13 + R-19 (RDL.3)	R-19 + R-11 LS (RES.3)
		IMPs (DETAIL)	2" (RIMP)	2.5" (RIMP)	2.5" (RIMP)	2.5" (RIMP)	2.5" (RIMP)	3" (RIMP)	3" (RIMP)	4" (RIMP)
	Walls	U-Factors	0.093	0.093	0.084	0.084	0.069	0.069	0.057	0.057
		Fiberglass (DETAIL)	R-19 (WSL.3)	R-19 (WSL.3)	R-19 (WSL.3)	R-19 (WSL.3)	R-25 + R-0.75 TSB (WES.1)	R-25 + R-0.75 TSB (WES.1)	R-30 + R-3 TSB (WES.1)	R-30 + R-3 TSB (WES.1)
		IMPs (DETAIL)	2" (WIMP)	2" (WIMP)	2" (WIMP)	2" (WIMP)	2" (WIMP)	2" (WIMP)	2.5" (WIMP)	2.5" (WIMP)

CONDITIONED SPACE IECC 2012		Zone 1	Zone 2	Zone 3	Zone 4 (EXCEPT MARINE)	Zone 5 Marine 4	Zone 6	Zone 7	Zone 8	
Prescriptive Compliance	Roof	U-Factors	0.044 ⁵	0.035 ⁵	0.035 ⁵	0.035	0.035	0.031	0.029	0.029
		Fiberglass w/R-5 TSB (DETAIL)	R-30 ² TRAP (RSL.3) or R-19 + R11 LS (RES.3)	R-19 + R-11 LS (RES.3)	R-19 + R-11 LS (RES.3)	R-19 + R-11 LS (RES.3)	R-19 + R-11 LS (RES.3)	R-25 + R11 LS (RES.3)	R-30 + R-11 LS (RES.3)	R-30 + R-11 LS (RES.3)
		IMPs (DETAIL)	3" (RIMP)	4" (RIMP)	4" (RIMP)	4" (RIMP)	4" (RIMP)	5" (RIMP)	5" (RIMP)	5" (RIMP)
	Walls	U-Factors	0.079	0.079	0.079	0.052	0.052	0.052	0.052	0.052
		Fiberglass (DETAIL)	R-25 + R-0.75 TSB (WES.1)	R-25 + R-0.75 TSB (WES.1)	R-25 + R-0.75 TSB (WES.1)	R-30 + R-0.75 TSB (WES.1)	R-30 + R-0.75 TSB (WES.1)	R-30 + R-0.75 TSB (WES.1)	R-30 + R-0.75 TSB (WES.1)	R-30 + R-0.75 TSB (WES.1)
		IMPs (DETAIL)	2" (WIMP)	2" (WIMP)	2" (WIMP)	2.5" (WIMP)	2.5" (WIMP)	2.5" (WIMP)	2.5" (WIMP)	2.5" (WIMP)

CONDITIONED SPACE IECC 2015-2018		Zone 1	Zone 2	Zone 3	Zone 4 (EXCEPT MARINE)	Zone 5 Marine 4	Zone 6	Zone 7	Zone 8	
Prescriptive Compliance	Roof	U-Factors	0.044 ⁶	0.035 ⁶	0.035 ⁶	0.035	0.035	0.031	0.029	0.029
		Fiberglass w/TSB (DETAIL)	R-30 ² TRAP (RSL.3) OR R-19 + R11 LS (RES.3)	R-19 + R-11 LS (RES.3)	R-19 + R-11 LS (RES.3)	R-19 + R-11 LS (RES.3)	R-19 + R-11 LS (RES.3)	R-25 + R11 LS (RES.3)	R-30 + R-11 LS (RES.3)	R-30 + R-11 LS (RES.3)
		IMPs (DETAIL)	3" (RIMP)	4" (RIMP)	4" (RIMP)	4" (RIMP)	4" (RIMP)	5" (RIMP)	5" (RIMP)	5" (RIMP)
	Walls	U-Factors	0.079	0.079	0.079	0.052	0.052	0.052	0.052	0.052
		Fiberglass (DETAIL)	R-25 + R-0.75 TSB (WES.1)	R-25 + R-0.75 TSB (WES.1)	R-25 + R-0.75 TSB (WES.1)	R-30 + R-0.75 TSB (WES.1)	R-30 + R-0.75 TSB (WES.1)	R-30 + R-0.75 TSB (WES.1)	R-30 + R-0.75 TSB (WES.1)	R-30 + R-0.75 TSB (WES.1)
		IMPs (DETAIL)	2" (WIMP)	2" (WIMP)	2" (WIMP)	2.5" (WIMP)	2.5" (WIMP)	2.5" (WIMP)	2.5" (WIMP)	2.5" (WIMP)

CONDITIONED SPACE IECC 2021-2024		Zone 0	Zone 1	Zone 2	Zone 3	Zone 4 (EXCEPT MARINE)	Zone 5 Marine 4	Zone 6	Zone 7	Zone 8	
Prescriptive Compliance	Roof	U-Factors	0.035 ⁶	0.035 ⁶	0.035 ⁶	0.035 ⁶	0.035	0.035	0.031	0.029	0.026
		Fiberglass w/TSB (DETAIL)	R-19 + R-11 LS (RES.3)	R-19 + R-11 LS (RES.3)	R-19 + R-11 LS (RES.3)	R-19 + R-11 LS (RES.3)	R-19 + R-11 LS (RES.3)	R-19 + R-11 LS (RES.3)	R-25 + R11 LS (RES.3)	R-30 + R11 LS (RES.3)	R-25 + R-11 + R-11 LS (RFC.3)
		IMPs (DETAIL)	4" (RIMP)	4" (RIMP)	4" (RIMP)	4" (RIMP)	4" (RIMP)	4" (RIMP)	5" (RIMP)	5" (RIMP)	6" (RIMP)
	Walls	U-Factors	0.079	0.079	0.079	0.079	0.052	0.050	0.050	0.044	0.039
		Fiberglass (DETAIL)	R-25 + R-0.75 TSB (WES.1)	R-25 + R-0.75 TSB (WES.1)	R-25 + R-0.75 TSB (WES.1)	R-25 + R-0.75 TSB (WES.1)	R-30 + R-0.75 TSB (WES.1) or R-25 + R-10 (WES.2)	R-25 + R-10 (WES.2)	R-25 + R-10 (WES.2)	R-25 + R-19 (WES.2)	R-30 + R-19 (WES.2) or R-25 + R-10 + R-3 TSB (WDL.1)
		IMPs (DETAIL)	2" (WIMP)	2" (WIMP)	2" (WIMP)	2" (WIMP)	2.5" (WIMP)	2.5" (WIMP)	2.5" (WIMP)	3" (WIMP)	3" (WIMP)

See pages 20 - 23 for roof and wall details illustrating the insulation solutions
 Trap – NBG trapezoidal panel with R-3.75 TSB is required to achieve the performance indicated

National Energy Codes of Canada for Buildings

2011-2015		Zone 4 <3000	Zone 5 3000 to 3999	Zone 6 4000 to 4999	Zone 7A 5000 to 5999	Zone 7B 6000 to 6999	Zone 8 ≥ 7000	
Prescriptive Compliance	Roof	U-Factors	0.227	0.183	0.183	0.162	0.162	0.142
		Loc Seam or CFR Panel Fiberglass w/R-3 TSB UNO (DETAIL) Avg. purlin spacing min 52"	R-19 + R-11 LS (RES.3) or R-19 + R-11 + R-5 TSB FC (RFC.3)	R-25 + R-11 LS (RES.3) or R-19 + R-25 + R-3.75 TSB (RRB.1) ⁴	R-25 + R-11 LS (RES.3) or R-19 + R-25 + R-3.75 TSB (RRB.1) ⁴	R-25 + R-11 + R-11 LS (RFC.3) or R-19 + R-38 + R-3.75 TSB (RRB.1) ⁴	R-25 + R-11 + R-11 LS (RFC.3) or R-19 + R-38 + R-3.75 TSB (RRB.1) ⁴	
		SS360 Panel Fiberglass w/R-3 TSB UNO (DETAIL) Avg. purlin spacing min 52"	R-19 + R-11 LS (RES.3)	R-25 + R-11 LS (RES.3) or R-19 + R-25 + R-3.75 TSB (RRB.1)	R-25 + R-11 LS (RES.3) or R-19 + R-25 + R-3.75 TSB (RRB.1)	R-25 + R-11 + R-11 LS (RFC.3) or R-25 + R-38 + R-3.75 TSB (RRB.1)	R-25 + R-11 + R-11 LS (RFC.3) or R-25 + R-38 + R-3.75 TSB (RRB.1)	
		IMPs (DETAIL)	4" (RIMP)	5" (RIMP)	5" (RIMP)	5" (RIMP)	5" (RIMP)	6" (RIMP)
	Walls	U-Factors	0.315	0.278	0.247	0.210	0.210	0.183
		Fiberglass (DETAIL)	R-30 + R-0.75 TSB (WES.1)	R-25 + R-10 (WES.2)	R-25 + R-19 (WES.2)			
		IMPs (DETAIL)	2.5" (WIMP)	2.5" (WIMP)	3" (WIMP)	4" (WIMP)	4" (WIMP)	4" (WIMP)

National Energy Codes of Canada for Buildings

2017		Zone 4 <3000	Zone 5 3000 to 3999	Zone 6 4000 to 4999	Zone 7A 5000 to 5999	Zone 7B 6000 to 6999	Zone 8 ≥ 7000	
Prescriptive Compliance	Roof	U-Factors	0.193	0.156	0.156	0.138	0.138	0.121
		Loc Seam or CFR Panel Fiberglass w/R-3 TSB UNO (DETAIL) Avg. purlin spacing min 52"	R-25 + R-11 LS (RES.3) or R-19 + R-19 + R-3.75 TSB (RRB.1) ⁴	R-25 + R-11 + R-11 LS (RFC.3) or R-25 + R-38 + R-3.75 TSB (RRB.1) ⁴	R-25 + R-11 + R-11 LS (RFC.3) or R-25 + R-38 + R-3.75 TSB (RRB.1) ⁴			
		SS360 Panel Fiberglass w/R-3 TSB UNO (DETAIL) Avg. purlin spacing min 52"	R-25 + R-11 LS (RES.3) or R-19 + R-19 + R-3.75 TSB (RRB.1)	R-25 + R-11 + R-11 LS (RFC.3) or R-25 + R-38 + R-3.75 TSB (RRB.1)	R-25 + R-11 + R-11 LS (RFC.3) or R-25 + R-38 + R-3.75 TSB (RRB.1)			
		IMPs (DETAIL)	4" (RIMP)	5" (RIMP)	5" (RIMP)	6" (RIMP)	6" (RIMP)	
	Walls	U-Factors	0.315	0.278	0.247	0.210	0.210	0.183
		Fiberglass (DETAIL)	R-30 + R-0.75 TSB (WES.1)	R-25 + R-10 (WES.2)	R-25 + R-19 (WES.2)			
		IMPs (DETAIL)	2.5" (WIMP)	2.5" (WIMP)	3" (WIMP)	4" (WIMP)	4" (WIMP)	4" (WIMP)

2020		Zone 4 <3000	Zone 5 3000 to 3999	Zone 6 4000 to 4999	Zone 7A 5000 to 5999	Zone 7B 6000 to 6999	Zone 8 ≥ 7000	
Prescriptive Compliance	Roof	U-Factors	0.164	0.156	0.138	0.121	0.117	0.110
		Loc Seam or CFR Panel Fiberglass w/R-3 TSB UNO (DETAIL) Avg. purlin spacing min 52"	R-25 + R-11 + R-11 LS (RFC.3) or R-19 + R-38 + R-3.75 TSB (RRB.1) ⁴	R-25 + R-11 + R-11 LS (RFC.3) or R-25 + R-38 + R-3.75 TSB (RRB.1) ⁴				
		SS360 Panel Fiberglass w/R-3 TSB UNO (DETAIL) Avg. purlin spacing min 52"	R-25 + R-11 + R-11 LS (RFC.3) or R-25 + R-38 + R-3.75 TSB (RRB.1)	R-25 + R-11 + R-11 LS (RFC.3) or R-25 + R-38 + R-3.75 TSB (RRB.1) ⁴				
		IMPs (DETAIL)	5" (RIMP)	5" (RIMP)	6" (RIMP)			
	Walls	U-Factors	0.290	0.265	0.240	0.215	0.190	0.165
		Fiberglass (DETAIL)	R-25 + R-10 (WES.2) or R-25 + R-0.375 TSB (WES.1)	R-25 + R-19 (WES.2)	R-25 + R-19 (WES.2)			
		IMPs (DETAIL)	2.5" (WIMP)	2.5" (WIMP)	3" (WIMP)	4" (WIMP)	4" (WIMP)	4" (WIMP)

See pages 20 - 23 for roof and wall details illustrating the insulation solutions

Chart Notes:

- For ASHRAE 90.1-2010 thru 2022 in Zones 0 and 1, roof U-Factors are realized if panel color utilized has:
 - minimum three-year aged solar reflectance of 0.55 and minimum three-year aged thermal emittance of 0.75; or
 - minimum three-year aged Solar Reflectance Index of 64. Otherwise, an increased roof insulation to U-0.028 is required. This can be accomplished by using
 - Fiberglass R-19 + R-38 + R-3.75 TSB (RRB.1) with CFR panel or,
 - Fiberglass R-25 + R-38 + R-3.75 TSB (RRB.1) with SS360 panel or,
 - Fiberglass R-25 + R-11 + R-11 LS (RFC.3) or,
 - 5" Insulated Metal Panel (RIMP).
- The system performance has been validated through the use of either hot box testing or finite element modeling.
- Zone 0 was introduced by ASHRAE in 2016.
- Loc Seam panels have not been tested with the R-Boost™ Elevated Insulation System. Detail RRB.1 only applies to trapezoidal panels.
- For IECC 2012 in Zones 1, 2, and 3, roof U-Factors are realized if panel color utilized has:
 - minimum three-year aged solar reflectance of 0.55 and minimum three-year aged thermal emittance of 0.75;
 - minimum three-year aged Solar Reflectance Index of 64;
 - minimum initial solar reflectance of 0.70 and minimum initial thermal emittance of 0.75; or
 - minimum initial Solar Reflectance Index of 82.
- For IECC 2015 — 2024 in Zones 0, 1, 2, and 3, roof U-Factors are realized if panel color utilized has:
 - minimum three-year aged solar reflectance of 0.55 and minimum three-year aged thermal emittance of 0.75; or
 - minimum three-year aged Solar Reflectance Index of 64.





KIRBY
BUILDING
SYSTEMS

a **NUCOR**® company

kirbybuildingsystems.com